

Air & Water[®]
TECHNOLOGY

Wizard-Kleen[®]

U.S. Patent No. 6,708,717 & U.S. Patent Pending

Model No. FDN-001

Nitrogen Valve & Standard Water Hose Connection

Dual Function Water/ Compressed Nitrogen Flushing System

An affordable, Earth-Friendly solution for cleaning and maintaining $\frac{3}{4}$ " A/C drainpipe pathways.

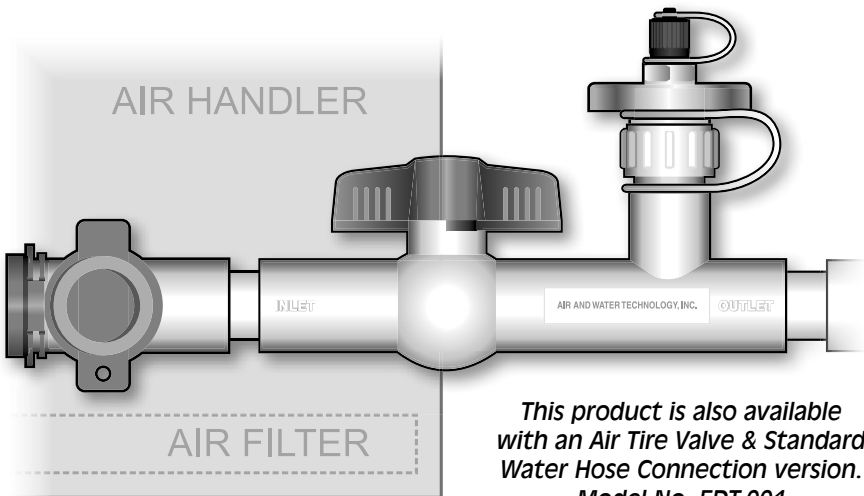

Air and Water Technology is a manufacturer of specialty hardware for the HVAC/R and the plumbing industry. See our web site at www.airwatertech.com



General Product Installation Instructions:

This product should be strictly installed only by an experienced and knowledgeable A/C professional technician. Where applicable apply PVC pipe cleaner and PVC adhesive glue to Wizard-Kleen® system installation. This product can be mounted offset from air handler not to block A/C air filter removal. (See diagram)

Existing A/C drain pipe Installation:

1. Simply cut the appropriate amount of existing A/C air handler condensation pipe line to accommodate the $\frac{3}{4}$ " 90° elbow dual cleanout adapter and Wizard-Kleen® body parts only. This should be as close to the handler as possible.
2. Place end of $\frac{3}{4}$ " 90° elbow dual cleanout adapter onto the just cut existing drain pipe. It should run horizontally or vertically & plum in front of the A/C air handler.

Proceed to step 3 of New Installation below.

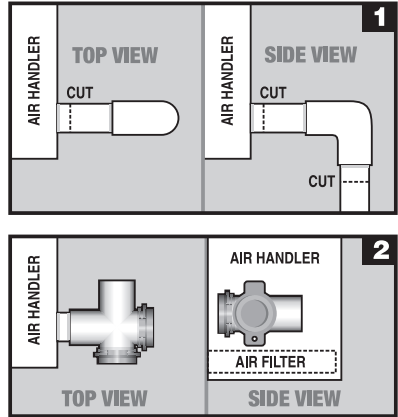

New A/C drain pipe adapter Installation:

1. Screw $\frac{3}{4}$ " male tapered threaded slip adapter directly to the A/C handler drain outlet on the primary A/C drain pan. This requires Teflon Tape to ensure a water-tight seal.
2. Place end of $\frac{3}{4}$ " 90° elbow dual cleanout adapter into the male slip adapter to run horizontally or vertically & plum in front of the A/C air handler.
3. Attach a pipe stub onto the end of the elbow dual cleanout adapter.
4. Slip the Wizard-Kleen® body inlet end onto the end of pipe stub.
5. Attach the outlet end of the Wizard-Kleen® body to the remaining condensation pipe line that runs to outside of the building for A/C water discharge. Check for plumbing leaks.

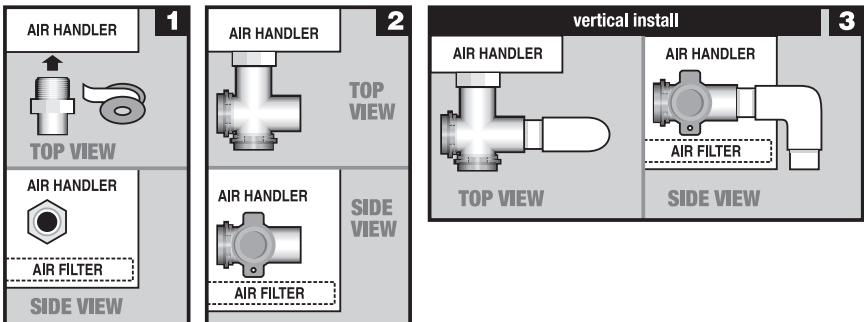

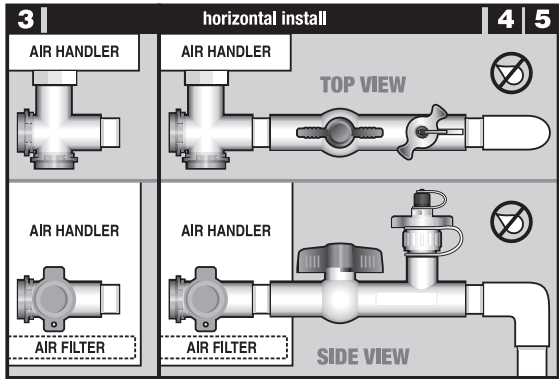
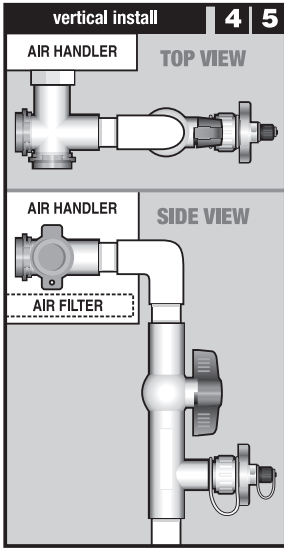

The Wizard-Kleen® Dual Flushing system is an environmentally friendly cleaning method which utilizes water or compressed gas — **WITHOUT THE USE OF CHEMICALS** — to flush sludge and slime from your A/C plumbing.

Note: This Wizard-Kleen® model design is suitable for use with 3/4" outlet only and may not handle larger commercial tonnage units. Please consult your A/C manufacture. This product should only be installed by an experienced & knowledgeable installer. Wizard-Kleen® must be installed strictly in accordance with manufacture instructions to insure proper operation including any & all local plumbing and drain codes as applicable.

General Product Cleaning Instructions:

It is recommended to flush your A/C plumbing at the same time your filter is changed.

Compressed Nitrogen Flushing:

Warning: This cleaning method should strictly be done by an experienced & knowledgeable A/C professional technician. Note: Requires the use of a gas regulator. Do not exceed **30 psi** when flushing nitrogen gas through drain pipe system.

1. Close main red valve on Wizard-Kleen.® The handle will be perpendicular to the Wizard-Kleen® body.
2. Remove Wizard-Kleen® nitrogen cap and attach gas hose to valve.

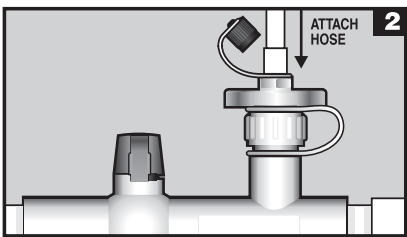
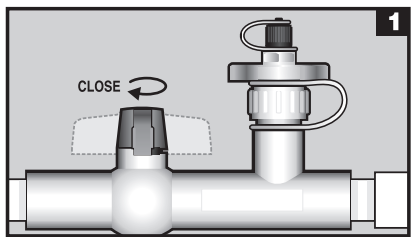

3. Set regulator to not exceed **30 psi**. Release nitrogen to begin flushing gas through A/C plumbing. Check your A/C drain pipe, located outside. Gas will flow unobstructed and clean when flushing is complete.
4. Shut off gas and remove nitrogen hose from Wizard-Kleen®
5. Replace Wizard-Kleen® nitrogen cap and re-open main red valve.

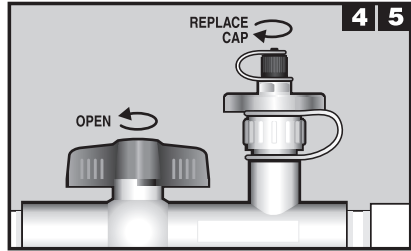
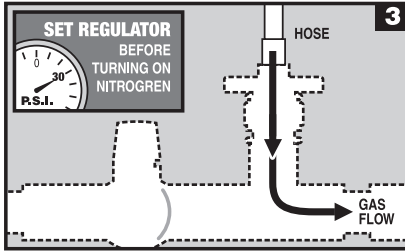

Water Flushing:

1. Close main red valve on Wizard-Kleen®. The handle will be perpendicular to the Wizard-Kleen® body. Remove Wizard-Kleen® nitrogen valve assembly.
2. Attach your water hose.
3. Turn on water faucet to begin flushing water through A/C plumbing. Check your A/C drain pipe, located outside. Water will flow unobstructed and clean when flushing is complete.
4. Shut off water at faucet and remove hose from Wizard-Kleen®
5. Replace Wizard-Kleen® nitrogen valve assembly and re-open main red valve.

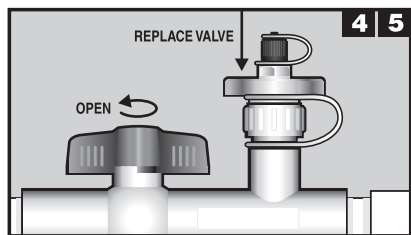
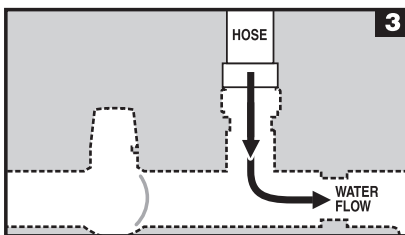
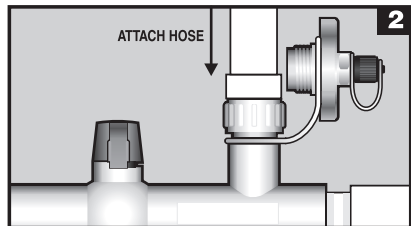
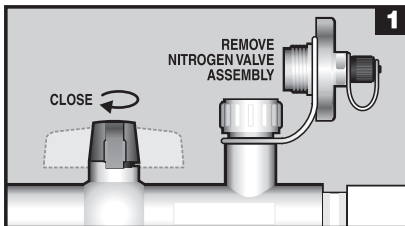

It is also recommended to maintain a scheduled inspection of your A/C drain line pipe as needed for optimum drain performance especially during summer time operations.

Wizard-Kleen® Limited Warranty

Air & Water Technology, Inc. (AWT) disclaims all implied and expressed warranties, including the implied warranty of merchantability and the implied warranty for fitness for a particular purpose, except as follows:

Wizard-Kleen® purchased by the consumer is unconditionally warranted to be free from defects in material and workmanship under normal use for a period of (1) one year from original date of purchase, providing it is installed and operated strictly in accordance with manufacture installation instructions. If this product is to be found defective or otherwise fails in normal use you may return it for replacement. All shipping charges for the return of this product shall be accepted by you the consumer. AWT will pay outgoing freight charges for replacement of product.

Defective products returned to Air & Water Technology, Inc. will be prepaid and at AWT's option repaired or replaced free of charge. Replacement of product will be based upon availability and AWT inventory to be a similar type and kind. AWT retains the right to substitute product if replacement product does not conform to terms of color, type and specifications to the original product, if no longer available.

This warranty does not cover replacement labor or any cost, claim or incident to any defect nor does it cover any consequential damages. The sole liability of the manufacturer under this warranty is limited to the replacement of defective product only. Product damaged by improper use, accident, and neglect, alterations, abuse or improper installation is excluded from this warranty.

AWT reserves the right to visit the site of the installation or require documentation of the claim before assuming any responsibility under the provisions of this Warranty. U.S. consumer legal rights under law may vary from state to state.

Wizard-Kleen® Water/Compressed Nitrogen Flushing System Model No. FDN-001 Parts

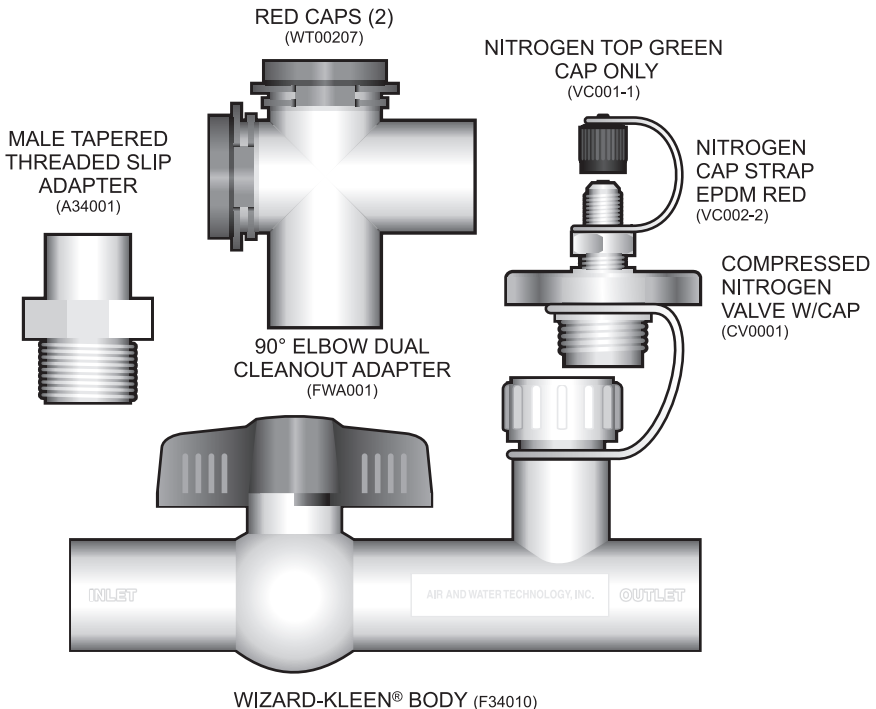

Wizard-Kleen® Benefits:

- Eliminates build up of algae, mold, fungus, mildew plus sludge & slime and odors.
- Reduces water damage from drain line back-up.
- Eliminates mess and unnecessary service calls.
- Easy to maintain — Saves time, labor and money.
- Uses no chemicals and is Environmentally Friendly.
- Can be mounted horizontally or vertically.
- Easily attaches to a standard water hose and nitrogen hose fitting.
- ¼ turn ball valve prevents back flow into A/C unit.
- Made of durable white Schedule 40 PVC (polyvinyl chloride).
- For ¾" residential and commercial use.
- A complimentary attachment to a new or existing air handler.
- No access needed to open air handler system.
- Two convenient cleaning options in one product.

Bag contents:

- One Wizard-Kleen® PVC body with a nitrogen valve cap system
- One ¾" PVC threaded screw male slip adapter
- One ¾" PVC 90° elbow dual cleanout adapter
- One instruction sheet

This product is also available with an Air Tire Valve & Standard Water Hose Connection version. Model No. FDT-001

**Our company motto is simple:
"Offer safe, easy and reliable solutions
for the HVAC/R and plumbing industry."**

2293 West 76th Street • Hialeah, FL 33016
305 823-8191 • fax: 305 823-8192

www.airwatertech.com